

ROLLING COUNTER DOOR

# ROLLING SHUTTER®

Model ESC10

## MEASURE THE WIDTH AND HEIGHT OF THE OPENING

### DOOR SIZE AND AREA

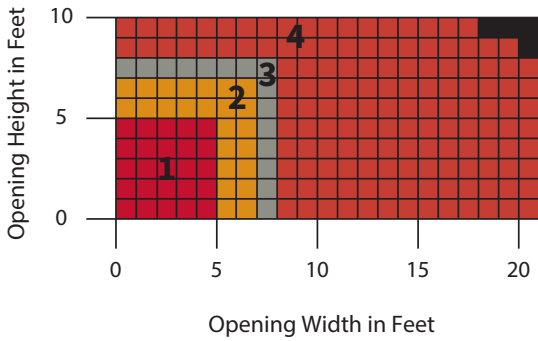

### COMPONENT DIMENSIONS

Reference the zone number to view component dimensions for motorized doors.

1	11	11	3	5
2	11	11	3	5
3	12	12	3	5
4	13	13	3	5

Dimensions in Inches

Zone A B C D

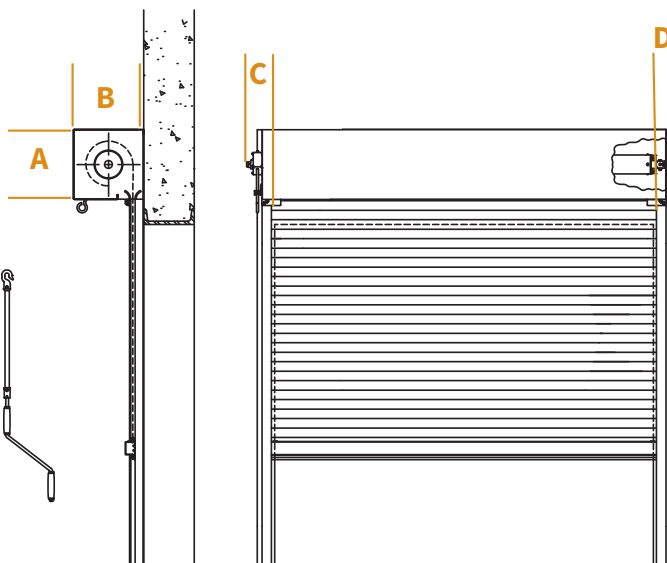

### SLAT CROSS SECTION

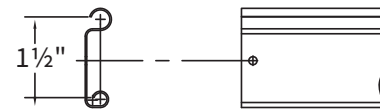

The dimensions featured on this sheet are provided as a guide. Please visit our website at [www.cooksondoor.com/drawings](http://www.cooksondoor.com/drawings) to generate drawings on demand with exact dimensions.

# ROLLING COUNTER DOOR **ROLLING SHUTTER Model ESC10**

## GUIDE CONSTRUCTION OPTIONS

### EXTRUDED ALUMINUM

#### FACE OF WALL

Used most often, guides are mounted to the interior or exterior side of the wall.

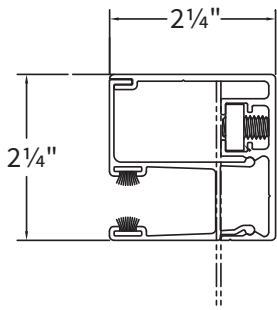

#### BETWEEN JAMB

Used when side clearance is minimal, guides are mounted to the inside of the jamb.

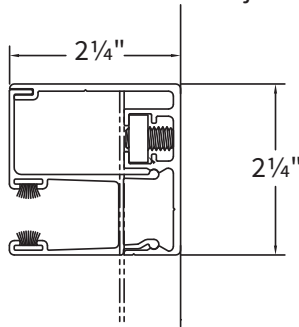

#### BETWEEN JAMBS WITH TUBES

Typically used if there's no wall support, and tubes and guides need to be recessed within the wall construction

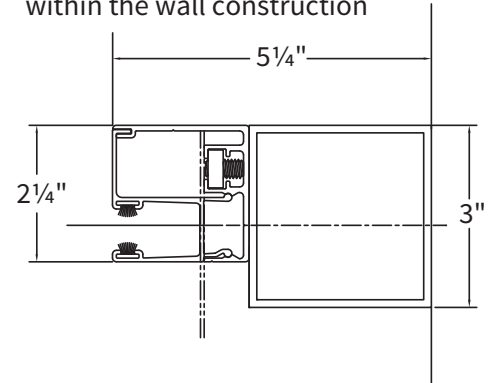

### STEEL

#### FACE OF WALL

Used most often, guides are mounted to the interior or exterior side of the wall.

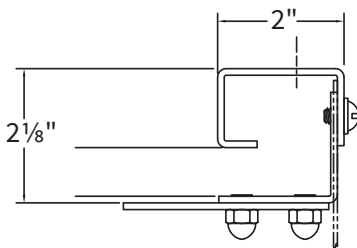

#### BETWEEN JAMB

Used when side clearance is minimal, guides are mounted to the inside of the jamb.

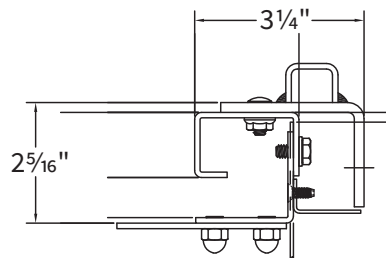

#### BETWEEN JAMBS WITH TUBES

Typically used if there's no wall support, and tubes and guides need to be recessed within the wall construction

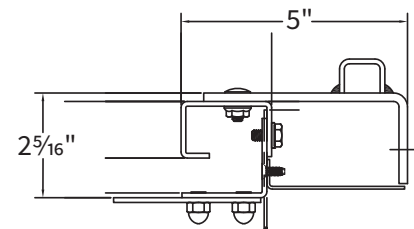

The dimensions featured on this sheet are provided as a guide. Please visit our website at [www.cooksondoor.com/drawings](http://www.cooksondoor.com/drawings) to generate drawings on demand with exact dimensions.

## CUSTOM-DESIGNED SOLUTIONS

Our experienced Architectural Design Support Team can customize our products to fit your specific application. Call 800.294.4358 ext. 1280 or email [ads@cooksondoor.com](mailto:ads@cooksondoor.com).